



EDW-120

Serial Adapter

General information

Legal information

The contents of this document are provided “as is”. Except as required by applicable law, no warranties of any kind, either express or implied, including, but not limited to, the implied warranties of merchantability and fitness for a particular purpose, are made in relation to the accuracy and reliability or contents of this document. Westermo reserves the right to revise this document or withdraw it at any time without prior notice.





Under no circumstances shall Westermo be responsible for any loss of data or income or any special, incidental, and consequential or indirect damages howsoever caused.

More information about Westermo can be found at www.westermo.com.

Safety and Regulations

Warning signs are provided to prevent personal injuries and/or damages to the product.

The following levels are used:

Level of warning	Description	Consequence personal injury	Consequence material damage
 WARNING	Indicates a potentially hazardous situation	Possible death or major injury	Major damage to the product
 CAUTION	Indicates a potentially hazardous situation	Minor or moderate injury	Moderate damage to the product
 NOTICE	Provides information in order to avoid misuse of the product, confusion or misunderstanding	No personal injury	Minor damage to the product
 NOTE	Used for highlighting general, but important information	No personal injury	Minor damage to the product

Safety Information

Before installation:

Read this manual completely and gather all information on the product. Make sure that you understand it fully. Check that your application does not exceed the safe operating specifications for this product.



WARNING - SAFETY DURING INSTALLATION

The product must be installed and operated by qualified service personnel and installed into an apparatus cabinet or similar, where access is restricted to service personnel only.

During installation, ensure a protective earthing conductor is first connected to the protective earthing terminal (only valid for metallic housings). Westermo recommends a cross-sectional area of at least 4 mm².

If the product does not have a protective earthing terminal, then the DIN-rail must be connected to protective earth. Upon removal of the product, ensure that the protective earthing conductor, or the connection to earth via the DIN-rail, is disconnected last.



WARNING - HAZARDOUS VOLTAGE

Do not open an energized product. Hazardous voltage may occur when connected to a power supply.



WARNING - PROTECTIVE FUSE

The power supply wiring must be sufficiently fused. It must be possible to disconnect manually from the power supply. Ensure compliance to national installation regulations.

Replacing the internal fuse must only be performed by Westermo qualified personell.



WARNING - REDUCE THE RISK OF FIRE

To reduce the risk of fire, use only telecommunication line cords with a cable diameter of AWG 26 or larger. Regarding power cable dimensions, see Interface Specifications.



CAUTION - ELECTROSTATIC DISCHARGE (ESD)

Prevent electrostatic discharge damages to internal electronic parts by discharging your body to a grounding point (e.g. use a wrist strap).

Care recommendations

Follow the care recommendations below to maintain full operation of product and to fulfil the warranty obligations:

- Do not drop, knock or shake the product. Rough handling above the specification may cause damage to internal circuit boards.
- Use a dry or slightly water-damp cloth to clean the product. Do not use harsh chemicals, cleaning solvents or strong detergents.
- Do not paint the product. Paint can clog the product and prevent proper operation.

If the product is used in a manner not according to specification, the protection provided by the equipment may be impaired.

If the product is not working properly, contact the place of purchase, nearest Westermo distributor office or Westermo technical support.

Product disposal

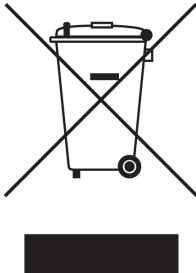

This symbol means that the product shall not be treated as unsorted municipal waste when disposing of it. It needs to be handed over to an applicable collection point for recycling electrical and electronic equipment.

By ensuring this product is disposed of correctly, you will help to reduce hazardous substances and prevent potential negative consequences to both environment and human health, which could be caused by inappropriate disposal.

Simplified EU declaration of conformity

Hereby, Westermo declares that the equipment is in compliance with EU directives.

The full EU declaration of conformity and other detailed information are available at the respective product page at www.westermo.com.

Agency approvals and standards compliance

Type	Approval / Compliance
EMC	EN 61000-6-2, Immproducty industrial environments
	EN 61000-6-4, Emission industrial environments

FCC Part 15.105 Notice:

This equipment has been tested and found to comply with the limits for a Class A digital device, pursuant to Part 15 of the FCC Rules. These limits are designed to provide reasonable protection against harmful interference when the equipment is operated in a commercial environment.

This equipment generates, uses, and can radiate radio frequency energy and, if not installed and used in accordance with the instruction manual, may cause harmful interference to radio communications. Operation of this equipment in a residential area is likely to cause harmful interference in which case the user will be required to correct the interference at his own expense.

Type tests and environmental conditions

Electromagnetic Compatibility			
Phenomena	Test	Description	Test levels
ESD	EN 61000-4-2	Enclosure contact	± 6 kV
		Enclosure air	± 8 kV
RF field AM modulated	IEC 61000-4-3	Enclosure	20V/m 80% AM (1 kHz), 80 – 2 000 MHz 12V/m 80% AM (1 kHz), 2 000 – 2 700 MHz
RF field 900 MHz	ENV 50204	Enclosure	20 V/m pulse modulated 200 Hz, 900 ± 5 MHz
Fast transient	EN 61000-4-4	Signal ports	± 2 kV
		Power ports	± 2 kV
Surge	EN 61000-4-5	Signal ports unbalanced	± 2 kV line to earth, ± 2 kV line to line
		Signal ports balanced	± 2 kV line to earth, ± 1 kV line to line
		Power ports	± 2 kV line to earth, ± 2 kV line to line
RF conducted	EN 61000-4-6	Signal ports	10 V 80% AM (1 kHz), 0.15 – 80 MHz
		Power ports	10 V 80% AM (1 kHz), 0.15 – 80 MHz
Pulse magnetic field	EN 61000-4-9	Enclosure	1000 A/m, 6.4 / 16 µs pulse
Radiated emission	CISPR 16-2-3	Enclosure	EN 61000-6-4
	ANSI C63.4		FCC part 15
Conducted emission	CISPR 16-2-1	DC power ports	EN 61000-6-4
Dielectric strength	UL 60950-1	Signal port to other isolated ports	1.5 kVrms 50 Hz 1 min
		Power port to other isolated ports	2 kVrms 50 Hz 1 min
Environmental			
Temperature		Operating	-25 to +70°C
		Storage & Transport	-40 to +70°C
		Maximum surface temperature	135°C (temperature class T4)
Humidity		Operating	5 to 95% relative humidity
		Storage & Transport	5 to 95% relative humidity
Altitude		Operating	2 000 m / 70 kPa
Service life		Operating	10 year
Vibration	IEC 60068-2-6	Operating	7.5 mm, 5 – 8 Hz
			2 g, 8 – 500 Hz
Shock	IEC 60068-2-27	Operating	15 g, 11 ms
Packaging			
Enclosure			
EDW-120	UL 94	PC / ABS	Flammability class V-1
Dimension W x H x D			35 x 121 x 121 mm
Weight			0.2 kg
Degree of protection	IEC 529	Enclosure	IP 21
Cooling			Convection
Mounting			Horizontal on 35 mm DIN-rail

Introduction

The EDW-120 is an Industrial Ethernet to serial adapter. The serial interface has two parallel RS-232 ports. The Ethernet interface is 10/100BASE-T and supports the following networking protocols: TCP, UDP, ICMP, IGMP, HTTP, ARP.

Two EDW-120 can be used to provide a serial point to point link over an Ethernet network using either UDP or TCP. When using TCP the EDW-120 can be configured as client or server.

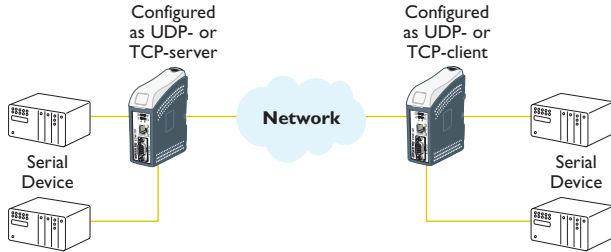

Each product passes data from its serial interface to the serial interface of the other product. This enables long distance serial communication using pre-existing networks.

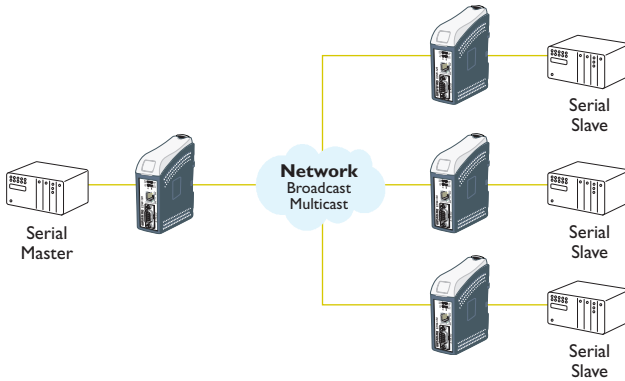

When EDW-120 is used with the UDP protocol it is also possible to communicate one to many (e.g. master to multiple slaves), by using a broadcast address or multicast addressing

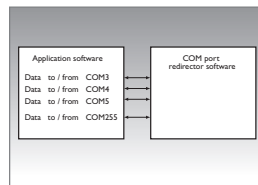
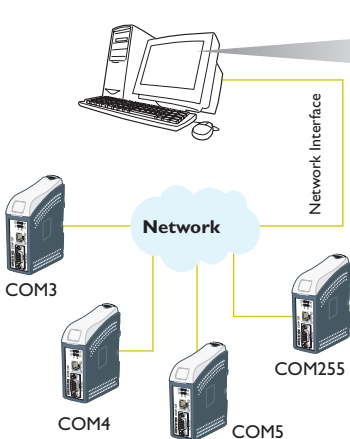

EDW-120 can also provide a remote serial interface for a computer connected through a TCP/IP network using a Virtual IP software.

A COM port redirector or customer written software can be used to create virtual COM ports. This software will redirect data, originally sent to a local COM port, to the remote serial interface of the EDW-120. No changes are required on the computer application software.

Together with the product Virtual IP is delivered, this software enables connection of 255 COM ports to virtual IP addresses.

On the network side the EDW-120 has two serial server applications implemented at each RS-232 port. The servers listen at different local TCP ports. Each serial server application allows remote clients to connect. When a connection is established any data sent to the server are transmitted at the corresponding serial interface. CH1 or CH2. Vice versa data received at CH1 or CH2 are packed into a frame and sent to the remote client. The serial channels are possible to configure individually (e.g. individual packing algorithm and data format).

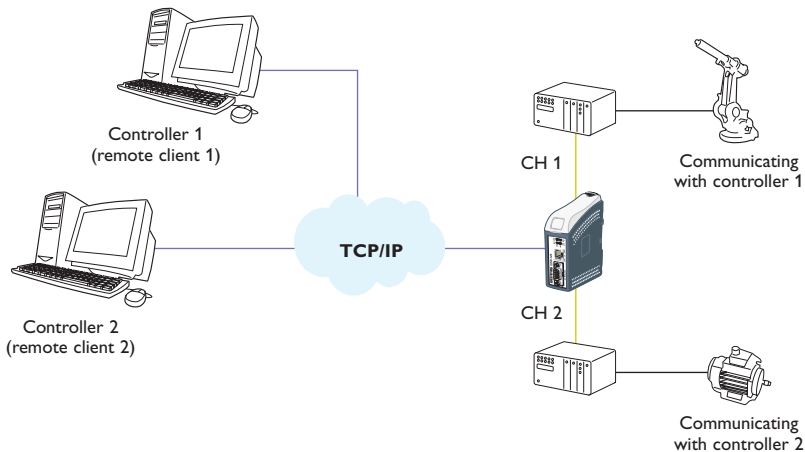

It is also possible to direct the two serial servers to the same serial channel, useful for redundant SCADA.

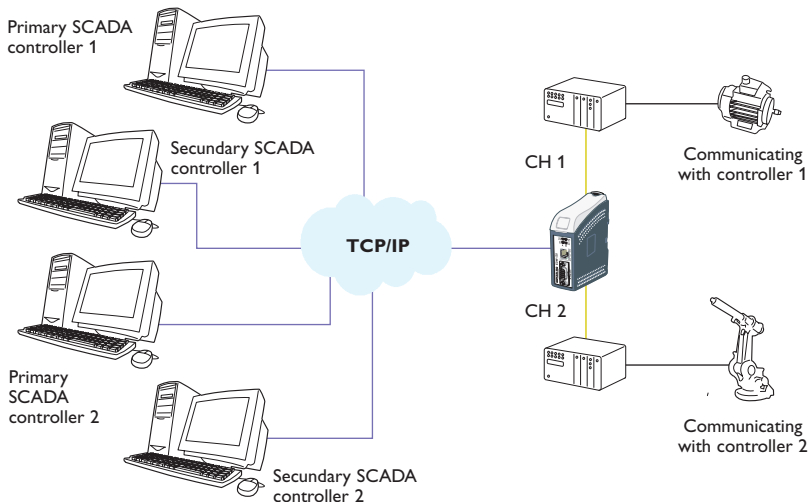

For more information on applications and technical data visit www.westermo.com. The Web tool also includes an integrated help where all functions and modes are described in details.

More help can be found inside the web tool and the "?" button on each configuration page

Product description

The EDW-120 is an industrial Ethernet to serial interface adapter designed for harsh environments.

It allows serial devices to interface through a new or existing Ethernet network. The product can support two RS-232, running at up to 115.2 kbit/s. Ethernet connection is via a standard RJ-45 port with MDI/MDI-X.

The protocols used for network communication is UDP or TCP. This allows the EDW-120 to be setup as a TCP-server or -client as well as an UDP product.

Configuration of the product

The EDW-120 can be easily configured via the onboard Web based configuration tool, alternatively some functions can also be set by hardware DIP-switches on the PCB.

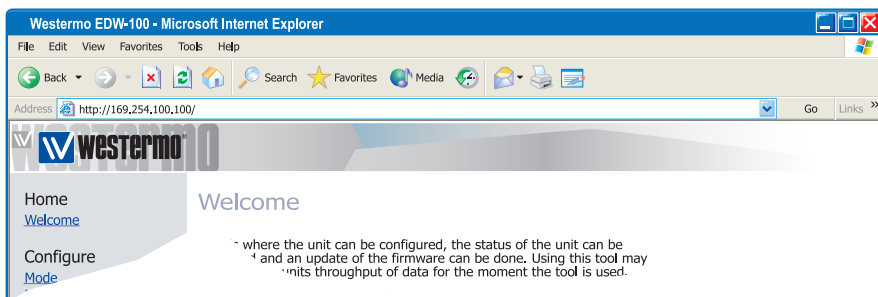

It is also possible to monitor and override the hardware settings by using the Web tool, if that is done this is indicated by the RC LED (Remotely Controlled).

The serial port properties such as data rate, flow control and data bits etc. are configured by the Web based configuration tool.

The local IP address of the product can be configured by using a terminal program such as Windows Hyper Terminal.

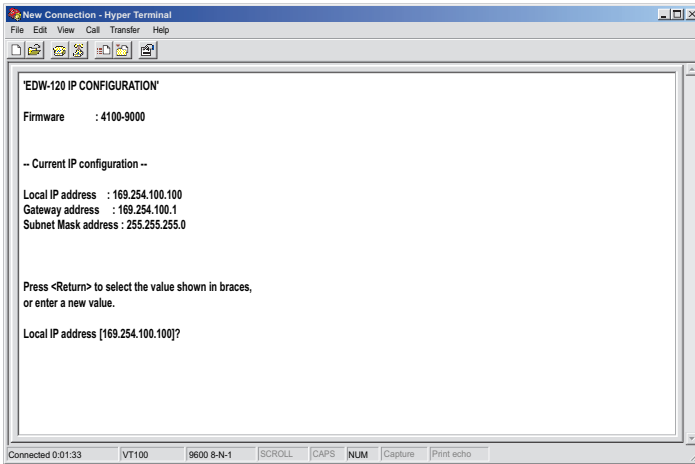

Unique features

- ⌘ Packing algorithm that enables the user to decide how and when the serial data should be encapsulated in a TCP or UDP data frame and sent out on the network.
- ⌘ Galvanic isolation, this feature eliminates communication errors. One of the most common errors is caused by potential differences between interconnected equipment.
- ⌘ Redundant power supply with wide input range.

These features along with the high EMC immunity enable the device to be used in projects where a high degree of reliability is required.

Diagnostic information

The first level of diagnostic information is the status indicated by the LEDs. LED is described on page 25.

The Telnet diagnostic service provide the user with information such as UDP- or TCP mode, connected or listening state (TCP) etc.

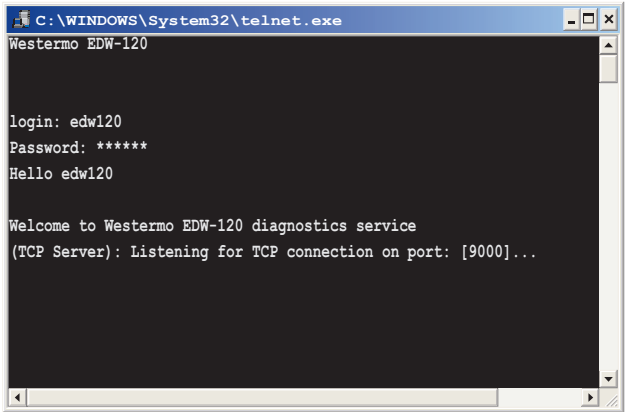

Getting started

IP Address

The default IP address of the EDW-120 when delivered is 169.254.100.100

Default port 9000 (A: RS-232)

Default port 9001 (B: RS-232)

Default gateway 169.254.100.1

IP address configuration

The IP address is configurable by the Web tool and/or by using a terminal program.

Below is an description of how to configure the IP address by using a terminal program.

1. Connect the serial A: RS-232 interface to a terminal program with settings:

Data rate: 9600 bit/s

Data bits: 8

Stop bits: 1

Parity: None

Flow control: None

Note! When connecting EDW-120 to a Comport in a computer you have to use a “null-modem” cable, because both EDW-120 and the computer interface is DTE.

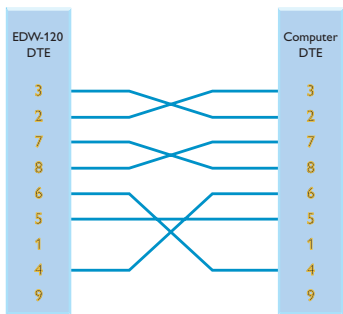

2. Setting DIP S1:1 to 'On' and power-up the EDW-120 this will enable the local IP address to be configured via serial interface.



Once connected with the terminal program you can change the IP address, Gateway address and Subnet Mask according to the picture below:

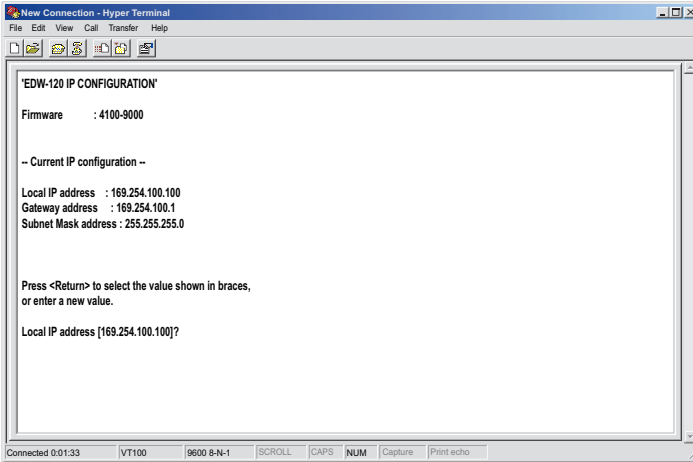

See also configuration by Web Tool on page 18

3. Set DIP S1:1 to 'Off' and power cycle the EDW-120.
4. The product is now ready for a complete configuration by the Web tool.

Username and Password for configuration

The EDW-120 is username and password protected. These are used when connecting with Web browser during configuration and with Telnet for diagnostics.

Default username: edw120

Default password: edw120

Browser Login

The Webtool has two different login accounts.

The first is the EDW-120 Guest account that only allows the user to read the products settings but he has no rights to configure the product in any way. This accounts Username and Password are fixed and aren't configurable

EDW-120 Guest

Username: guest

Password: guest

or

Username: anonymous

Password: anonymous

EDW-120 Config

The second account is the EDW-120 Config that gives the user rights to configure the product with new parameter values. This accounts Username and Password can also be configured when the user are logged in as EDW-120 Config. Default Username and Password are listed below.

Default Username: edw120

Default Password: edw120

Restore Factory default settings



Note! This will clear your customized settings.

The factory default settings can be restored using DIP-switch S1:2.

1. Force this to 'On' and Power-up the EDW-120 for at least 5 seconds.
2. Force the DIP-switch to 'Off' and power cycle the EDW-120.

The EDW-120 now contains the factory default settings.

Note ! If the default address of the product is valid on the connected network it is possible to access the product directly from a browser.

Configuration by Web Tool

The EDW-120 includes an easy-to-use Web configuration tool. The Web tool is very intuitive and includes useful help information for the configurable parameters.

Connect and login to the EDW-120 with the EDW-120 Config account on the default IP address and with default username- and password combination (or your customized if configured) using a standard Web browser.

Use the Configuration Wizard to set all parameters then press the button "Program Product" to write the parameters into the product or save the parameters to a file.

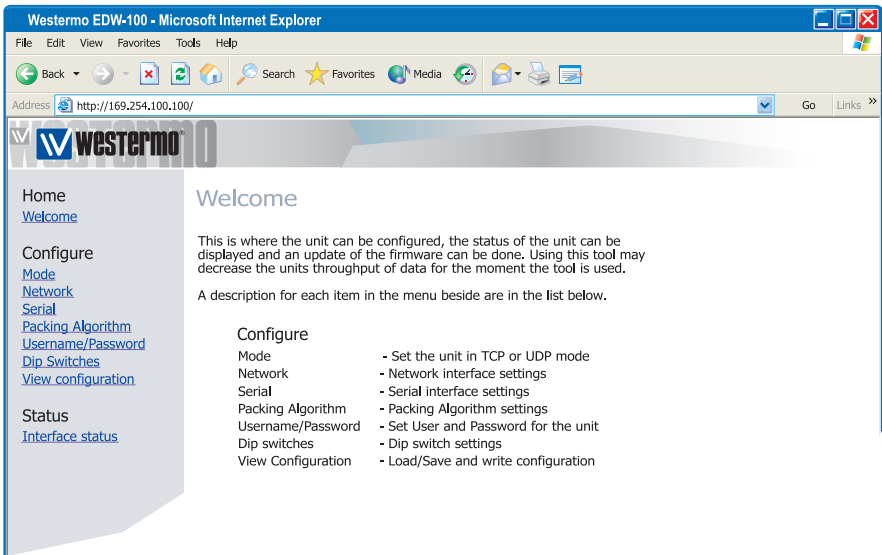
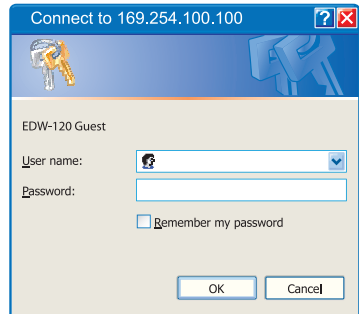

Serial/IP® and Telnet Options

EDW-120 are bundled with Serial/IP® virtual Com port director software. The Serial/IP® use portions of the "Telnet Environment Option" (RFC1572) to verify that it is connected to an EDW-120.

The EDW-120 has partial support for the "Telnet Com Port Control Option" (RFC2217). This makes it possible to remotely (on the fly) change serial port parameters. Currently supported parameters are baud rate, parity, number of data bits and number of stop bits.

As default the Telnet Options are disabled. If the Serial/IP® software is to be used, the Telnet options must be enabled in the web tool. This parameter can be found on the serial page.

Diagnostics via Telnet

The EDW-120 provides the user with diagnostics information via a Telnet connection on port 23.

Information presented to the user is:

- ⌘ Operational mode (UDP, TCP-server or client)
- ⌘ Operational status (Listening for connection (TCP server), connected to host (TCP server or client), Attempting to connect (TCP client))
- ⌘ The 'Status' LED on the EDW-120 will lit during Telnet session.

Below is an description of how to start a Windows Telnet session and get diagnostics information from the EDW-120.

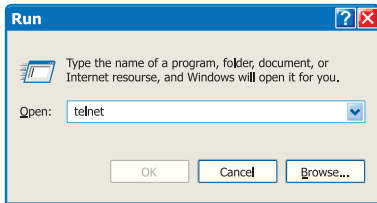

1. Start a Telnet session.

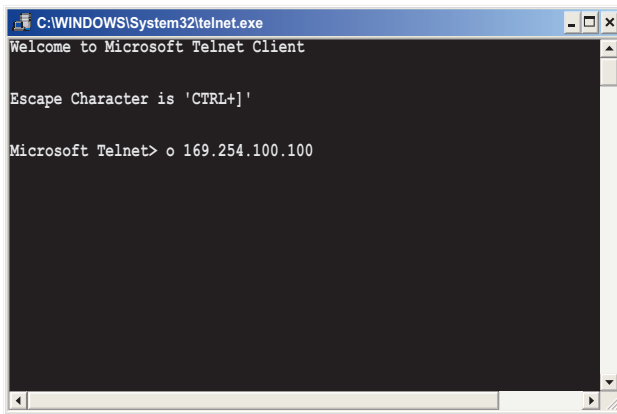

2. Connect to EDW-120 by typing 'o 169.254.100.100' or the configured IP address of the EDW-120.
3. Login using default username and password (or your customized settings if configured).

Application modes

The EDW-120 can be setup for use in one of three different application modes:

- ⌘ TCP Server
- ⌘ TCP Client
- ⌘ UDP

Short description of TCP and UDP

User Datagram Protocol (UDP)

UDP provides a connectionless datagram service. This means that the arrival of datagram's or data packets is not controlled and the reliability of the communication is the responsibility of the application layer protocol. In this way UDP is a simpler method of communication than TCP. As data is sent and received without any established connection the data transfer is more efficient and often faster. UDP is therefore used in applications that require efficient use of the bandwidth and also have a higher level protocol to handle lost data.

Transmission Control Protocol (TCP)

TCP is a connection-oriented delivery service. Connection oriented means that a connection must be established before hosts can exchange data. An acknowledgement is used to verify that the data was received by the other host. For data segments sent, the receiving host must return an acknowledgement (ACK). If an ACK is not received, the data is retransmitted. Flow-control between the hosts is managed by TCP. For larger amounts of data that have to be split between packets TCP provides a method for reliably reassembling the data in the correct order. Because of the requirement to establish a connection and acknowledge transmissions, TCP takes longer time to transmit data than UDP and uses more bandwidth.

When delivered the EDW-120 is in **TCP server** mode.

TCP Server mode

This mode makes it possible to accept incoming TCP connections attempts to the EDW-120 from an TCP client e.g. a EDW-120 in TCP client mode. Other examples of TCP clients: Telnet client establishing a raw TCP connection, COM-port redirector software running on a Windows PC.

TCP Client mode

This mode makes it possible to establish a TCP connection to a remote TCP server e.g. a EDW-120 in TCP Server mode.

DSR signal rising or a powering up the product will trigger the EDW-120 to make an connection attempt to the specified server depending on configuration.

UDP mode

UDP is a connection less protocol sending datagram's i.e. there are less overhead traffic compared to TCP and no acknowledgement packets will be sent between the peer's during communication.

Using UDP will enable the EDW-120 to send and listen to broadcast- and multicast messages.

Packing algorithm

When data arrives at the serial port of the EDW-120 there must be one or more criteria fulfilled to trigger the EDW-120 to encapsulate the received serial data into a frame and send it out on the network.

These criteria are setup using different parameters i.e. the 'packing algorithm'. The default settings are selected to be compatible to most applications but can be optimized to the customer specific application. Detailed description can be received from the Web configuration tool.

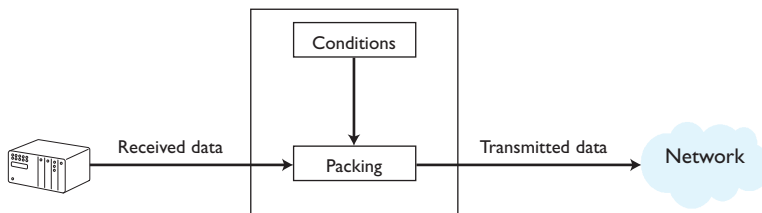

Advanced settings

Advanced settings configure the product for special application requirements or special interface functions, these settings are default disabled.

Detailed description can be received from the Web configuration tool.

Interface specifications

Power LV	
Rated voltage	12 to 48 VDC
Operating voltage	10 to 60 VDC
Rated current	200 mA @ 12 VDC 100 mA @ 24 VDC 50 mA @ 48 VDC
Rated frequency	DC
Maximum inrush current @ 10 ms	0.13 A ² s @ 48 VDC
Power up current	< 0.3 A. Sensitive power supplies need current limit >= 0.3A
Polarity	Reverse polarity protected
Redundant power input	Yes
Isolation to	All other 2 k V _{rms}
Connection	Detachable screw terminal
Connector size	0.2 – 2.5 mm ² (AWG 24 – 12)
Shielded cable	Not required
RS-232	
Electrical specification	EIA RS-232
Data rate	300 bit/s – 115.2 kbit/s
Data format	7 or 8 data bits, Odd, even or none parity, 1 or 2 stop bits.
Protocol	Transparent, optimised by packing algorithm
Retiming	Not applicable
Circuit type	SELV
Transmission range	15 m
Isolation to	Power 2 kV _{rms} Ethernet 1; 1.5 kV _{rms}
Connection	9-pin D-sub male (DTE)
Shielded cable	Not required, except when installed in Railway applications as signalling and telecommunications apparatus and located close to rails*
Conductive housing	Isolated to all other circuits
Number of ports	2 (port A and B)

* To minimise the risk of interference, a shielded cable is recommended when the cable is located inside 3 m boundary to the rails and connected to this port. The cable shield should be properly connected (360°) to an earthing point within 1 m from this port. This earthing point should have a low impedance connection to the conductive enclosure of the apparatus cabinet, or similar, where the product is built-in. This conductive enclosure should be connected to the earthing system of an installation and may be directly connected to the protective earth.

Ethernet 1	
Electrical specification	IEEE std 802.3. 2000 Edition
Data rate	10 Mbit/s or 100 Mbit/s, auto-negotiated or manually set by DIP-switches
Protocol	UDP, TCP, ICMP, HTTP and ARP
Duplex	Full- or half duplex, auto-negotiated or manually set by DIP-switches
Circuit type	TNV-1
Transmission range	100 m
Isolation to	Power 2 kV _{rms} RS-232 1.5 kV _{rms} RS-422/485 1.5 kV _{rms}
Connection	RJ-45 shielded, auto MDI/MDI-X
Shielded cable	Not required, except when installed in Railway applications as signalling and telecommunications apparatus and located close to rails*
Conductive housing	Isolated to all other circuits

* To minimise the risk of interference, a shielded cable is recommended when the cable is located inside 3 m boundary to the rails and connected to this port.

The cable shield should be properly connected (360°) to an earthing point within 1 m from this port. This earthing point should have a low impedance connection to the conductive enclosure of the apparatus cabinet, or similar, where the product is built-in. This conductive enclosure should be connected to the earthing system of an installation and may be directly connected to the protective earth.

Connections

S1 DIP-switch under lid
(for details see page 26)

LED indicators, also
integrated in the RJ-45
connector.
(for details see next page)

Ethernet 1
RJ-45 connection
(for details see next page)

**Power connection
screw terminal**

4-position	Description
No. 1	Common
No. 2	+VA
No. 3	+VB
No. 4	Common

RS-232 (DTE)

9-position	Direction	Description
No. 1	N/C	Not connected (DCD)
No. 2	In	Received Data (RD)
No. 3	Out	Transmitted Data (TD)
No. 4	Out	Data Terminal Ready (DTR)
No. 5	–	Signal Ground (SG)
No. 6	In	Data Set Ready (DSR)
No. 7	Out	Request To Send (RTS)
No. 8	In	Clear To Send (CTS)
No. 9	N/C	Not connected (RI)

NC Not Connected

Ethernet 1

(Auto-Negotiation disabled^{**})

Position	Direction*	Signal name	Description/Remark
No.1	In	Transmit +	Transmit data
No.2	In	Transmit -	Transmit data
No.3	Out	Receive + (-/)	Receive data, auto-polarity ^{**}
No.4	-	-	Terminated
No.5	-	-	Terminated
No.6	Out	Receive - (/+)	Receive data, auto-polarity ^{**}
No.7	-	-	Terminated
No.8	-	-	Terminated
Shield	-	Shield	HF-connected to COM (via capacitor)

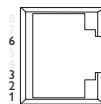

CAT 5 cable is recommended. Unshielded (UTP) or shielded (STP) connector might be used.

- * Direction relative this product.
 - ** Disable auto-negotiation also disables auto crossover (auto MDI/MDI-X).
 - ** Auto-polarity always enabled an only relevant for 10BaseT.
- NOTE!** Pin number and signal name relations might be changed by auto crossover or auto polarity.

LED Indicators

LED	Status	Description
PWR Power	OFF	No internal power
	ON	Internal Power OK
TD (A and B) Transmit data	OFF	No serial data transmitted from A and B: RS-232
	ON	Serial data transmitted from A and B: RS-232
RD (A and B) Receive data	OFF	No serial data received to A and B: RS-232
	ON	Serial data received to A and B: RS-232
LINK	OFF	No Ethernet link. Cable not connected.
	ON	Good Ethernet link.
	Flash	Ethernet data is transmitted or received, traffic indication.
STAT Status	OFF	Normally Off
	ON	Telnet session established to Telnet diagnostics service or Ongoing configuration by Web tool.
RC Remotely controlled	OFF	DIP switch settings are valid.
	ON	One or more DIP switches are overrid by remote configuration.
SPD Speed Integrated in RJ-45 Green	ON	Mbit/s
	OFF	Mbit/s
DPX Duplex Integrated in RJ-45 Yellow	ON	Full duplex
	OFF	Half duplex

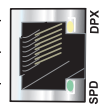
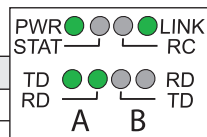

Installation

Mounting / Removal



WARNING - HAZARDOUS VOLTAGE

Do not open an energized product. Hazardous voltage may occur when connected to a power supply.



CAUTION - ELECTROSTATIC DISCHARGE (ESD)

Prevent electrostatic discharge damages to internal electronic parts by discharging your body to a grounding point (e.g. use a wrist strap).

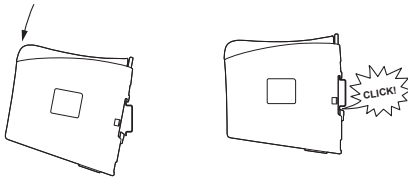

Mounting

This product should be mounted on 35 mm DIN-rail which is horizontally mounted on a wall or cabinet backplate.

Cooling

This product uses convection cooling. To avoid obstructing the airflow around the product, use the following spacing rules. Minimum spacing 25 mm (1.0 inch) above / below and 10 mm (0.4 inches) left / right the product. Spacing is recommended for the use of product in full operating temperature range and service life.

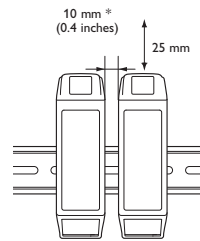

* Spacing (left/right) recommended for full operating temperature range

Removal Press down the black support at the back of the product, see figure.

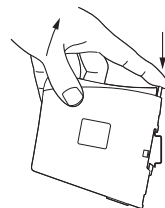

DIP-switch settings

DIP-switches are accessible under the lid on top of the product. DIP-switches are used to configure the product.



WARNING - HAZARDOUS VOLTAGE

Do not open an energized product. Hazardous voltage may occur when connected to a power supply.



CAUTION - ELECTROSTATIC DISCHARGE (ESD)

Prevent electrostatic discharge damages to internal electronic parts by discharging your body to a grounding point (e.g. use a wrist strap).

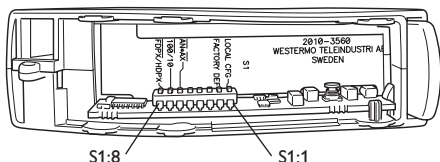

Factory settings



S1* DIP-switch



Normally OFF



Enable local IP configure via serial interface.

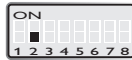

Normally OFF

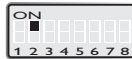

Restore factory default.



Ethernet Auto-negotiation enabled. Auto-crossover enabled. 10 Mbit/s.



Ethernet Auto-negotiation disabled. Auto crossover (MDI/MDIX) disabled. 10 Mbit/s.



Ethernet 100 Mbit/s when Auto-negotiation disabled

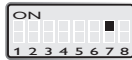

Ethernet 10 Mbit/s when Auto-negotiation disabled

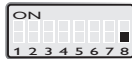

Ethernet Half Duplex Auto-negotiation disabled or is not supported.

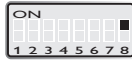

Ethernet Full duplex when Auto-negotiation disabled or is not supported.

* DIP switch functions may be override by WEB configuration tool. Override is indicated by RC LED. S3, S4, S5 not used.

Note! DIP-switch alterations are only effective after a power on.

A setting configured by any other method during normal operation, possibly overrides the DIP-switch setting. However, an override situation is indicated by the RC LED.

Applications

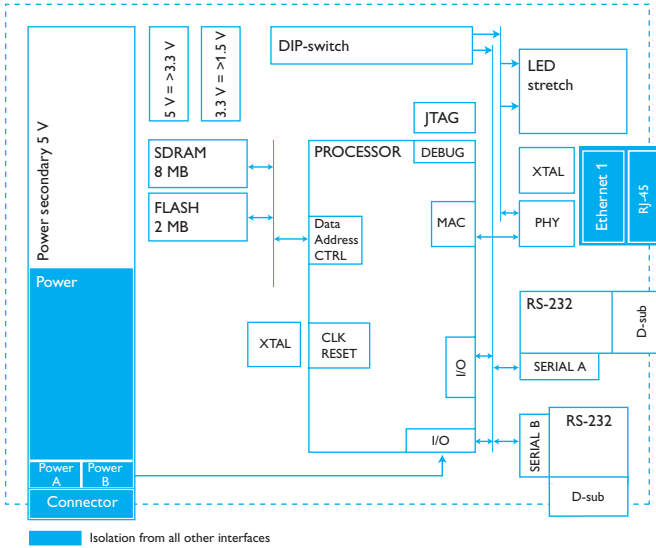

Buffer size

Transmit Buffer 8Kbyte.
Receive Buffer 8Kbyte.

One to many using UDP using broadcast or multicast

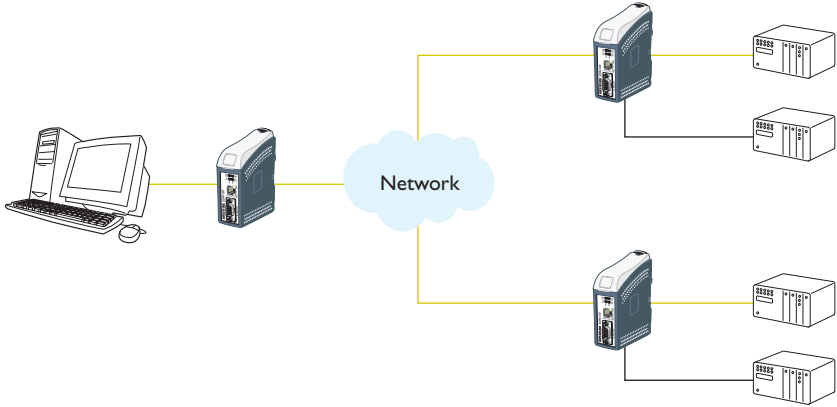

Description

The one to many function can be used in place of a traditional multidrop application. Data entering one of the EDW-120 will be broadcast or Multicast to any other device in the broadcast or multicast group. A typical application would be a SCADA host computer communicating to a number of PLC's.

Point to point using UDP connection

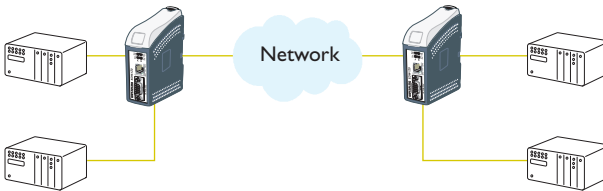

Description

In a point to point application the EDW-120 can replace or extend a cable link. The distance between the EDW-120 products is only limited by the size of the LAN. Data can be sent across the network using ether UDP or TCP. A typical application is serial connections between PLC's in industrial applications. To understand the differences between a UDP and TCP please see page 20.

Communication one to many using TCP

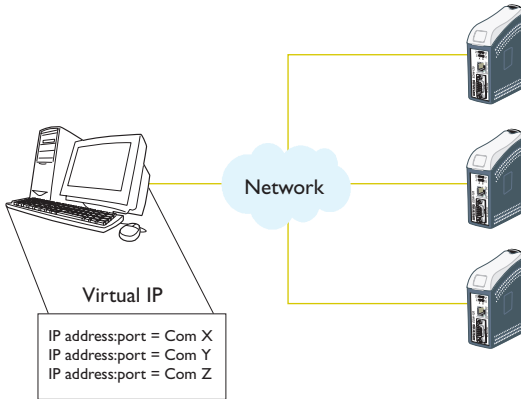

Description

Many legacy software applications do not have any facilities to directly use Ethernet but there is a requirement to use a newly installed or existing LAN to communication to many serial devices. This problem is solved by installing Comms redirection software on the host PC. The redirection software works by creating virtual comms ports on the computer. The Virtual comms port can be selected and use in the same way as a hardware based port. The Comms redirection software will encapsulate the serial data in a TCP/IP and send it to the relevant EDW-120 device. The EDW-120 will then strip off the TCP/IP frame and just forward the serial data to the target device. In the reverse direction the EDW-120 will encapsulate the data and the comms redirection software will strip off the TCP/IP frame. Together with the product Virtual IP is delivered, this software enables connection of 255 COM ports to virtual IP addresses.

WESTERMO

Westermo • Metallverksgatan 6, SE-721 30 Västerås, Sweden

Tel +46 16 42 80 00 Fax +46 16 42 80 01

E-mail: info@westermo.com

www.westermo.com